

Simon25plus



simon

De diseño europeo,
suaves líneas y formas
que armonizan
perfectamente con
todos los ambientes.



acabado madera roble

cava mate





Su gama de colores,
texturas y formas
actuales, se adaptan
a cualquier exigencia
arquitectónica.



aluminio mate

negro ébano



Una serie de máxima
calidad, diseñada
y fabricada con las
más exigentes normas
de calidad internacional.



rojo gaudí

blanco



Una serie que incorpora un sistema de seguridad patentado en todas sus tomas de corriente.



Cuando se introduce algún objeto en un solo borne, el sistema interno bloquea la entrada.

seguridad



Así cuidamos que tus hijos estén más seguros.

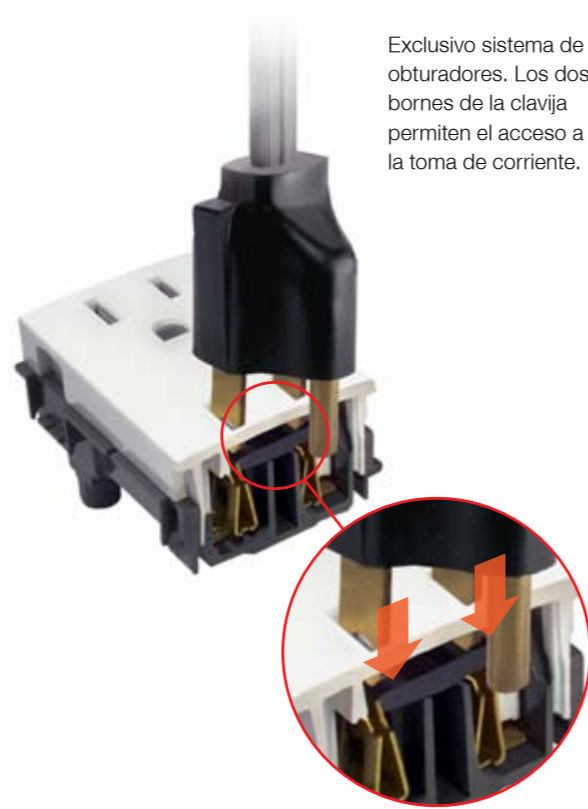

Exclusivo sistema de obturadores. Los dos bornes de la clavija permiten el acceso a la toma de corriente.

Máxima duración

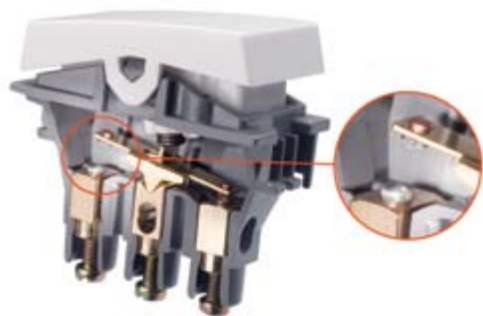

Contactos de plata que garantizan más de 40,000 maniobras en su mecanismo y por ello una larga vida de operación.

Un simple click



Todos los mecanismos se instalan a presión, quedando firmemente sujetos por un simple click.

Sistema Led



El sistema de luz piloto en los interruptores incorpora la tecnología más avanzada de iluminación a base de LED (diodos emisores de luz) de color azul.

Conexión

Los mecanismos permiten la conexión en cada borne de 2 conductores de calibre 12AWG (3.3 mm de sección).



Modularidad

Ejemplo de configuración

Pieza	Cant.	Referencia	Descripción
	1	25700 -38	Chasis
	1	25612-63	Placa 2 módulos
	1	25313 -38	Dimmer rotativo 300 Watts para lámpara incandescente y/o halógeno
	1	25104 -38	Interruptor sencillo 2 vías con visor para piloto
	1	25004 -39	Conjunto luminoso LED

La Serie Simón 25 plus, es la más versátil de todas, ya que puedes elegir de forma independiente el chasis, la placa y el mecanismo que deseas y crear ese ambiente que buscas.

Cava Mate



Acabado Madero Roble



Rojo Gaudi



Naranja



Blanco



gama de color



Aluminio Mate



Negro Ébano



Azul Baleares



Verde Abeto



Marfil

Artículos

Colores

- Grafito-38 Marfil-31-61 Blanco-30-61
 Aluminio-63 Cava-64 Azul-66 Rojo-67
 Verde-68 Negro-69 Madera-76 Naranja-59
 Consulte política de garantía

Placas (no incluye chasis)

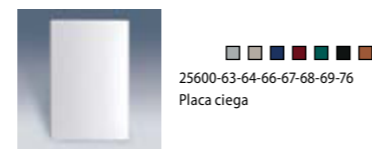
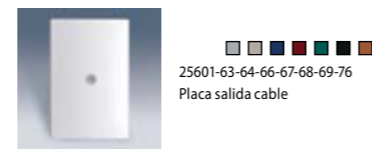
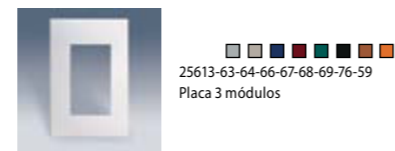
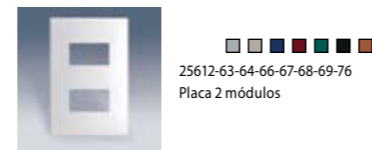
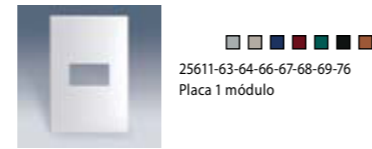

Chasis



Mecanismos de interrupción 10A 127V-

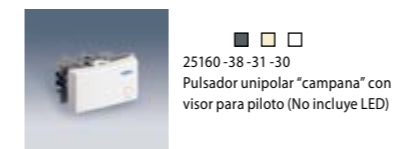
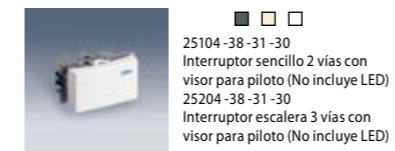

Otros mecanismos



Otros mecanismos



Tomas de corriente 10/15A 127V-

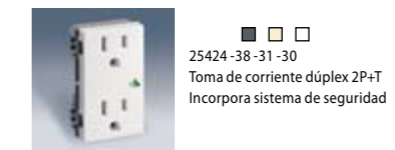
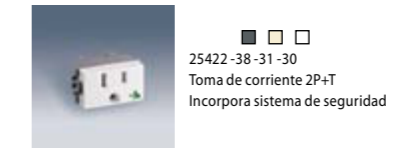
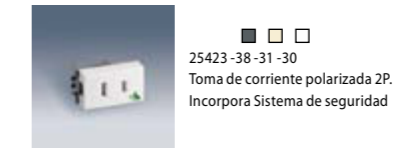

Elementos montados 10/15A 127/200V-

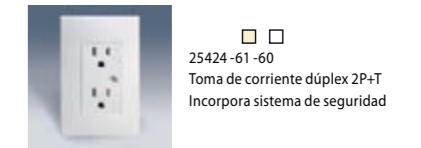
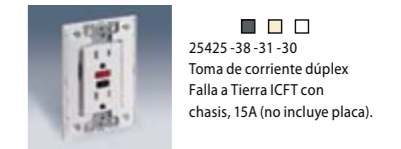

Placas con chasis

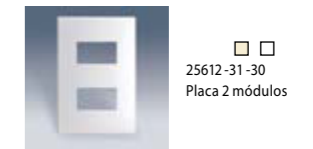
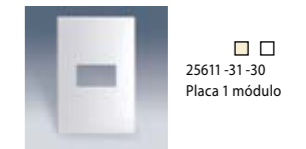

simon

Diseño y confort para tí

www.simonelectrica.com

OFICINAS CENTRALES

Carretera Naucalpan Toluca Km. 52
Calle 5, Lote 7 y 8
Col. Parque Industrial Toluca 2000
50200 Toluca, Edo. México
Tel: 01 722 249 63 47
mail: info@simonelectrica.com

Oficina Regional Centro:

Homero No. 425 Torre B piso 1
Col. Chapultepec Morales
Del. Miguel Hidalgo
C.P. 11570
Mexico DF
Tel: 5545-7865
mail: ventascentro@simonelectrica.com

Oficina Regional Pacífico:

Firmamento No. 755, Col. Jardines del Bosque
44520 Guadalajara, Jalisco
Tel: 0133 3123 0384 / 0133 3123 0385
mail: ventaspacifico@simonelectrica.com

Oficina Regional Norte:

Bosques de Canadá, No.104 Local No.12
Col. Bosques del Valle
66250 San Pedro Garza García, Nuevo León
Tel: 0181 8335 2116
mail: ventasnorte@simonelectrica.com

conectate con
simon 

 01800 00 **simon**
7 4 6 6 6
info@simonelectrica.com

- Soporte técnico
- Invitaciones a exposiciones
- Catálogos, material promocional
- Capacitación
- Novedades y promociones
- Comentarios y sugerencias